

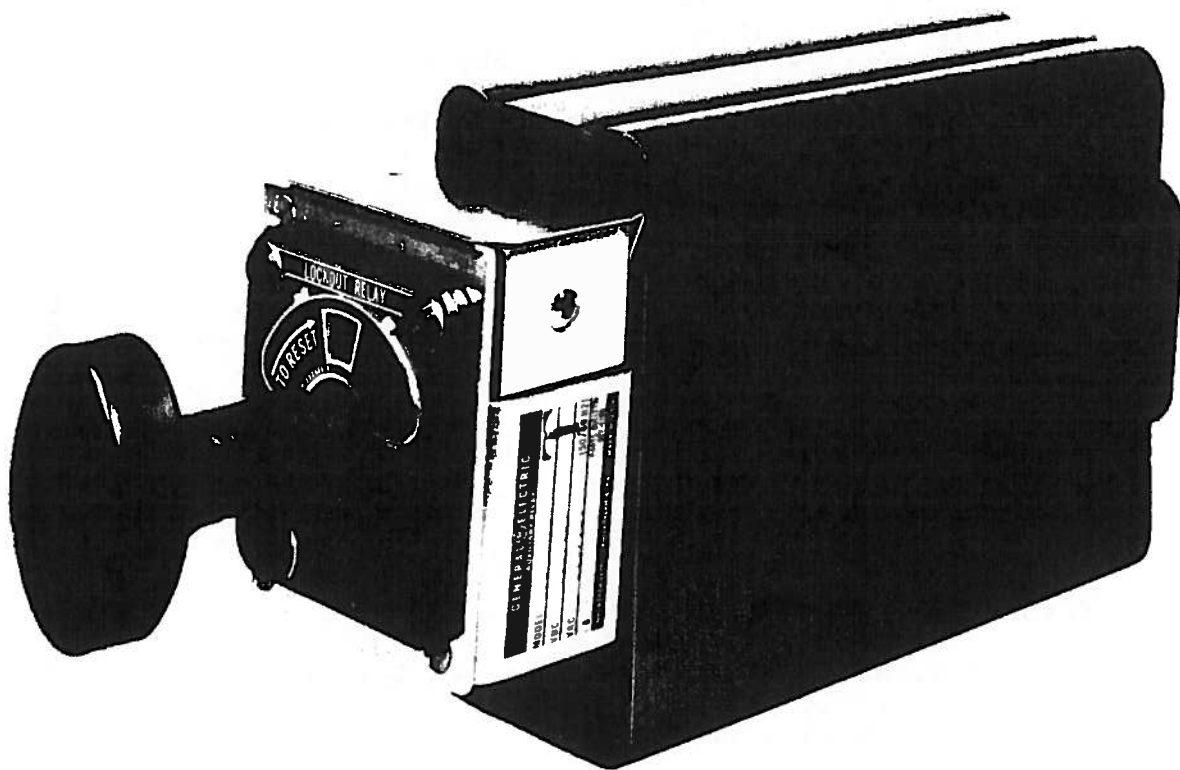

INSTRUCTIONS

AUXILIARY LOCKOUT RELAY
HAND RESET WITH TARGET



TYPE HSA11

*GE Meter and Control
205 Great Valley Parkway
Malvern, PA 19355-0715*

CONTENTS

	<u>PAGE</u>
DESCRIPTION	3
TABLE I - HSA BASIC MODELS	3
APPLICATION	3
RATINGS	4
SERVICE TEMPERATURE	4
DIELECTRIC CAPABILITY	4
TRIP COIL RATINGS	4
TABLE II - TRIP COIL VOLTAGE RATINGS	4
CONTACT RATINGS	4
TABLE III - CONTACT INTERRUPTING RATINGS	5
SEISMIC CAPABILITY	5
TABLE IV - HSA SEISMIC CAPABILITY	5
CHARACTERISTICS	5
OPERATING PRINCIPLE	5
OPERATING TIME VOLTAGE CHARACTERISTICS	5
TARGET DROPPING	6
TABLE V - TARGET DROPPING	6
BURDENS	6
TABLE VI - DC BURDENS	6
TABLE VII - AC BURDENS	7
SURGE VOLTAGE	7
MONITORING CURRENT	7
CONSTRUCTION	7
RECEIVING, HANDLING AND STORAGE	8
ACCEPTANCE TESTS	8
INSPECTION.....	8
TRIP TESTS	9
INSTALLATION PROCEDURE	9
MAINTENANCE	10
RENEWAL PARTS	10

HSA INSTRUCTION BOOK

DESCRIPTION

The Type HSA auxiliary relay is a high-speed, hand reset, multi-contact, lock-out relay, with an operating speed of approximately one half cycle trip time (60 cycle basis). The HSA features convenient means for front panel manual trip, a wiring cover and user changeable trip coils. It is available in three basic models, listed in TABLE I.

TABLE I - HSA BASIC MODELS

MODEL	STAGES	CONTACTS	DEPTH IN INCHES REQUIRED BEHIND PANEL	
			FOR MOUNTING	TO REMOVE COVER
12HSA11A(-)	6	9 + 2 for trip coil	6	9-1/2
12HSA11B(-)	8	13 + 2 for trip coil	7-1/4	12
12HSA11C(-)	11	19 + 2 for trip coil	9-1/8	15-3/4

Coil ratings for the standard AC and DC control voltages and any desired combination of circuit closing and circuit opening contacts are covered by the 132 forms available; these forms are listed in Fig. 3.

Panel space required for mounting is 2-7/8 inches wide x 3-3/8 inches high (5-3/8 inches if the cover is used) as shown by Outline, Panel Drilling and Internal Connections Drawing, Fig. 2.

APPLICATION

The Type HSA auxiliary relays are intended for application where a number of operations are to be performed simultaneously by the operation of a single auxiliary lockout relay. An important application of the Type HSA relay is in conjunction with differential relays, which protect transformers, rotating apparatus and buses. A typical application with such equipment is shown in Fig. 4. Some other functions that are typically performed by the HSA, in addition to tripping the main circuit breaker of a system, are: Operating an auxiliary breaker, opening a neutral line breaker, tripping main and auxiliary field discharge breakers and operating other auxiliary relays, which in turn perform various functions. It should be noted that the contacts, although electrically separate, are overlapping when the relay transfers from one position to the other; either from trip to reset or vice-versa. Overlapping means that all of the open contacts will close before the closed contacts open.

*Indicates Revision

These instructions do not purport to cover all details or variations in equipment nor to provide for every possible contingency to be met in connection with installation, operation or maintenance. Should further information be desired or should particular problems arise which are not covered sufficiently for the purchaser's purposes, the matter should be referred to the General Electric Company.

To the extent required the products described herein meet applicable ANSI, IEEE and NEMA standards; but no such assurance is given with respect to local codes and ordinances because they vary greatly.

RATINGS

SERVICE TEMPERATURE

The HSA will operate over an ambient temperature range of -20°C to +55°C and will not be damaged by storage ambients of -40°C to +65°C.

DIELECTRIC CAPABILITY

HSA relays are rated 600 volts in accordance with the Dielectric Test Section of Relay Standard ANSI/IEEE C37.90-1978.

TRIP COIL RATINGS

The three trip coils available for HSA relays have multiple voltage ratings as shown in TABLE II. To obtain maximum tripping speed, the coils are rated for intermittent duty only.

TABLE II - TRIP COIL VOLTAGE RATINGS

INTERMITTENT RATING (VOLTS)	FREQUENCY (Hz)	OPERATING RANGE (VOLTS)	COIL GROUP
48	DC	32 - 56	1
110	DC	70 - 140	2
125	DC	70 - 140	2
220	DC	140 - 280	4
250	DC	140 - 280	4
69	50/60	45 - 80	1
110	50/60	70 - 140	2
120	50/60	70 - 140	2
220	50/60	140 - 280	4
240	50/60	140 - 280	4

CAUTION: DO NOT HOLD THE RESET HANDLE IN THE RESET POSITION IF THE HSA WILL NOT RESET. FAILURE TO RESET INDICATES THAT THE TRIP COIL IS ENERGIZED. HOLDING THE RESET HANDLE IN THE RESET POSITION WITH THE TRIP COIL ENERGIZED AT RATED VOLTAGE WILL CAUSE RAPID COIL HEATING AND POSSIBLE INSULATION DAMAGE.

CONTACT RATINGS

Ratings of the contacts are:

Continuous - 20 amps
Closing - 30 amps

Contact interrupting ratings in amperes are given in TABLE III.

*Indicates Revision

*

TABLE III - CONTACT INTERRUPTING RATINGS

CIRCUIT VOLTS	NON-INDUCTIVE		INDUCTIVE (L/R - .04)	
	SINGLE CONTACT	TWO IN SERIES	SINGLE CONTACT	TWO IN SERIES
48 DC	10	50	4.5	26
125 DC	5	22	2.4	5
250 DC	0.9	3.9	0.8	1.5
			(cos θ = 0.4)	
125 AC	50	50	50	50
240 AC	50	50	50	50

SEISMIC CAPABILITY

The seismic capability of HSA N.O. (Normally Open) and N.C. (Normally Closed) contacts are given in TABLE IV.

TABLE IV - HSA SEISMIC CAPABILITY

SEISMIC CAPABILITY IN g's ZPA			
HSA RESET		HSA TRIPPED	
N.O.	N.C.	N.O.	N.C.
6.0	4.0	6.0	6.0

CHARACTERISTICS

OPERATING PRINCIPLE

The type HSA auxiliary relay is a high-speed, hand-reset, multi-contact lockout relay. High-speed operation is obtained by release of stored mechanical energy. Manual 45 degree clockwise rotation of the reset handle puts the indicator flag and all switch contacts into their reset positions. It also winds a torsion spring which is latched in the wound position at the end of reset motion. A solenoid releases this latch and the spring's stored energy when it is desired to rotate the switch contacts back to the tripped position. Provision is also made for manual trip operation from the front of the panel; this is an option which can be made non-accessible if front of panel tripping capability is not desired.

OPERATING TIME VOLTAGE CHARACTERISTICS

Operating time is the time required to trip the relay and is measured from the initial application of trip voltage to the solenoid coil to closing of the normally open contacts. Fig. 5A and Fig. 5B operating time curves were established using a resistive contact load. For those circuits with an L/R ratio of 0.04 (IEEE relay standard) or less and a current exceeding three amperes, the operating times will be approximately three milliseconds longer. Fig. 5A and Fig. 5B show typical DC voltage operating time characteristics. AC voltage operating time may be longer,

*

GEK-65513

*depending on where in the cycle voltage is applied. The opening time of normally closed contacts is approximately two to three milliseconds faster than the closing time of normally open contacts.

Universal targets in series with HSA trip coils increase HSA trip time. A typical increase in trip time for a single 0.2 ampere target and an HSA with a 125 VDC trip coil is 1.3 milliseconds.

TARGET DROPPING

TABLE V shows the maximum number and type of universal targets that can be dropped by the current pulse of HSA trip coils.

TABLE V - TARGET DROPPING

HSA COIL GROUP	COIL VOLTAGE	NUMBER OF PARALLEL TARGETS DROPPED		
		0.2 AMP	0.6 AMP	2.0 AMP
1	48 VDC	6	6	3
2	110 VDC	6	6	2
2	125 VDC	6	6	2
4	220 VDC	6	3	1
4	250 VDC	6	4	1

NOTE: A minimum of two parallel 0.2 ampere targets is recommended to assure tripping of 48 VDC HSA relays.

BURDENS

The DC Burden Data for the HSA relay are listed in TABLE VI.

TABLE VI - DC BURDENS

COIL GROUP	VOLTS	COIL RESISTANCE (OHMS AT 25°C ±10%)
1	48	2.85
2	110	11.8
2	125	11.8
4	220	65
4	250	65

"The maximum current in the operating coil circuit is approximately 70 percent of the value which would be obtained by dividing the DC voltages by the coil DC resistance. This is because the HSA contact in the operating coil circuit interrupts the current before it has built up to the E/R value."

* Revised since last issue

GEK-65513

The AC burden data for the HSA relay are listed in Table VII.

TABLE VII - AC BURDENS

COIL GROUP	VOLTS	FREQUENCY	Z (OHMS)	POWER FACTOR
1	69	60	10	0.866
2	110	60	11	0.874
2	120	60	11	0.874
4	220	60	156	0.71
4	240	60	156	0.71
1	69	50	9.6	0.89
2	110	50	10.6	0.91
2	120	50	10.6	0.91
4	220	50	143	0.77
4	240	50	143	0.77

SURGE VOLTAGE

The solenoid coil current is interrupted by contacts No. 1 and No. 3. The resulting surge voltage across these contacts is up to 600 volts.

MONITORING CURRENT

Indicating lights or other monitoring devices connected across contacts 1 and 3 allow low level current flow through the solenoid trip coil when the HSA is in the tripped condition. To prevent interference with manual reset, this current should not exceed 0.25 amperes.

CONSTRUCTION

The HSA Outline, Panel Drilling and Internal Connections Drawing is shown by Fig. 2. The HSA form numbers are listed in Fig. 3.

There are normally two double-break switch contacts per stage. These contacts are numbered from front to rear by confined marking strips on each side of the unit; see Fig. 6. Contacts No. 1 and No. 3 are used in series and dedicated to interrupting the trip solenoid current. Contact No. 2 is omitted, and the rest are for user application. A cover is available to slip over the contact section after it is wired. The rails inside the cover seat on the marker strips.

GEK-65513

The contact section of the HSA is attached to and driven by a trip mechanism containing a torsion spring, latch and a trip solenoid. The trip solenoid subassembly with its coil can be removed and replaced if it is desired to change the relay's trip voltage specification. See Fig. 7 and 8.

The HSA has two provisions for manual tripping. It can be tripped by depressing the solenoid plunger by inserting a blunt instrument through the access hole in the upper right hand side of the relay frame. This manual trip provision is provided for acceptance testing with the relay positioned to give access to the side of the relay.

For ease of maintenance testing, the HSA can be tripped manually when panel mounted, provided an access hole is drilled through the panel (see **INSTALLATION PROCEDURE**) and the circular knockout in the lower left corner of the HSA escutcheon is removed; removal of the knockout exposes a slotted stud. Turning the stud counterclockwise with a screwdriver releases the latch mechanism and trips the HSA.

There are no provisions to lubricate either contacts or trip mechanism of the HSA and none should be required. The HSA contacts are arc resistant silver cadmium oxide. The contacts should be cleaned only with a flexible burnishing tool. No liquid contact cleaning agents should be used.

There are no user adjustments on the HSA.

RECEIVING, HANDLING AND STORAGE

These relays, when not included as part of a control panel, will be shipped in cartons designed to protect them against damage. Immediately upon receipt of a relay, examine it for any damage sustained in transit. If injury or damage resulting from rough handling is evident, file a damage claim at once with the transportation company and promptly notify the nearest General Electric Apparatus Sales Office.

If the relays are not to be installed immediately, they should be stored in their original cartons in a place that is free from moisture, dust and metallic chips.

ACCEPTANCE TESTS

INSPECTION

Check the nameplate to ensure that the model number and rating of the relay agree with the purchase order. Remove the relay cover and check that the number of stages, contact arrangement, rated trip voltage and nameplate model number agree with the model number and form numerals listed by Fig. 3.

Loosen the one screw that secures the shield over the solenoid coil. Remove the shield. The last digit of the coil identification number is the coil group number. Check this digit against the coil group number and voltage rating in TABLE II.

Check that there are no broken, cracked or loose parts or any other signs of physical damage.

TRIP TESTS

Reset and trip the relay manually. To trip the relay manually, deflect the solenoid plunger by inserting a blunt instrument through the access hole in the upper right hand side of the relay frame.

Perform an electrical trip test at 50 percent of rated DC voltage of the coil group by inserting a resistance in series with the trip coil equal to the coil resistance listed in TABLE VI and applying rated DC voltage to the top connections of terminals 2 and 3 only long enough to trip the relay. The power source should be sufficiently stiff so that the trip voltage applied to the HSA solenoid coil will not dip more than five percent below the no load voltage. Remove the voltage immediately if the relay fails to trip; recheck manual tripping, reset operation and coil group number. Measure coil resistance and compare with the resistance value for the coil group in TABLE VI.

INSTALLATION PROCEDURE

The HSA relay is designed for mounting on panels up to a maximum 0.250 inch thick.

Before installing an HSA, the user is advised to review this instruction book in its entirety, especially the preceeding section on **ACCEPTANCE TESTS**. Assuming this has been done, the installation should proceed with the panel layout and drilling of the three mounting holes, one shaft and one (optional) manual trip access hole, as detailed by Fig. 2. This should be done in an area with sufficient depth behind the panel for cover removal (if used) - see Fig. 2.

Notice the manual trip knockout in the lower left corner of the escutcheon. This area may be broken through before or after mounting the escutcheon to provide access to the manual trip stud, or left intact in applications where front of panel manual trip accessibility is not desired. The three mounting screws should be installed with 15-20 inch-pounds of torque.

Wiring to the HSA, when completed, should be cabled together and clamped at a point near the mounting structure so that no distortions or loads will be imposed on the relay by tight or pulled wiring. All dressed leads should lay along the top or bottom of the relay. None should run across the side of the relay from top to bottom or the cover cannot be installed. The cover contains two heavy score lines on the top surface so that it may easily be broken out an appropriate amount to provide exit clearance for the top lead bundle. To establish the length of the breakout, use a knife tip or other sharp tool to score across the top of the cover between the two existing score lines. Use pliers to bend and break out the scored section. All terminal screws should be checked to make sure they are tight. These binder head, nickel-plated brass terminal screws are 8-36 x 1/4 inch long. Longer screws cannot be used without danger of internal damage to switch parts.

The HSA coil insulation system has a unity (1.0) electrolytic corrosion factor (the best possible) and is vacuum impregnated for long life. However, to further reduce the possibility of electrolytic corrosion, HSA coil connections to a DC bus should be made to the negative bus.

MAINTENANCE

During any scheduled outage of the equipment, and preferably at yearly intervals, the relay should be tripped electrically to ensure that it is in good operating condition, and that all the circuits are complete so that the breaker can be tripped. This electrical test may be performed at 50 percent rated voltage by inserting a resistor equal to the HSA coil resistance in series with the coil and applying normal rated voltage; also see the **ACCEPTANCE TESTS** section of this instruction. Care should be taken to apply the test voltage only long enough to trip the relay. Do not try to reset the relay with the trip circuit still energized.

Be sure the tie bolts are tight at 20 inch-pounds torque.

If necessary, contacts should be inspected and burnished with the flexible burnishing tool in the standard relay tool kit available from the factory. Do not use liquid contact cleaners.

RENEWAL PARTS

It is recommended that sufficient quantities of renewal parts be carried in stock to enable the prompt replacement of any that are worn, broken or damaged. Note that the contacts and cam followers vary from those used in older SBM switches and HSA relays, and parts from older devices must not be used in new HSA relays. Only new factory-supplied parts should be used as renewal parts.

When ordering renewal parts, address the nearest Sales Office of the General Electric Company, specify quantity required, name of the part wanted, and the complete model number of the relay for which the part is required.

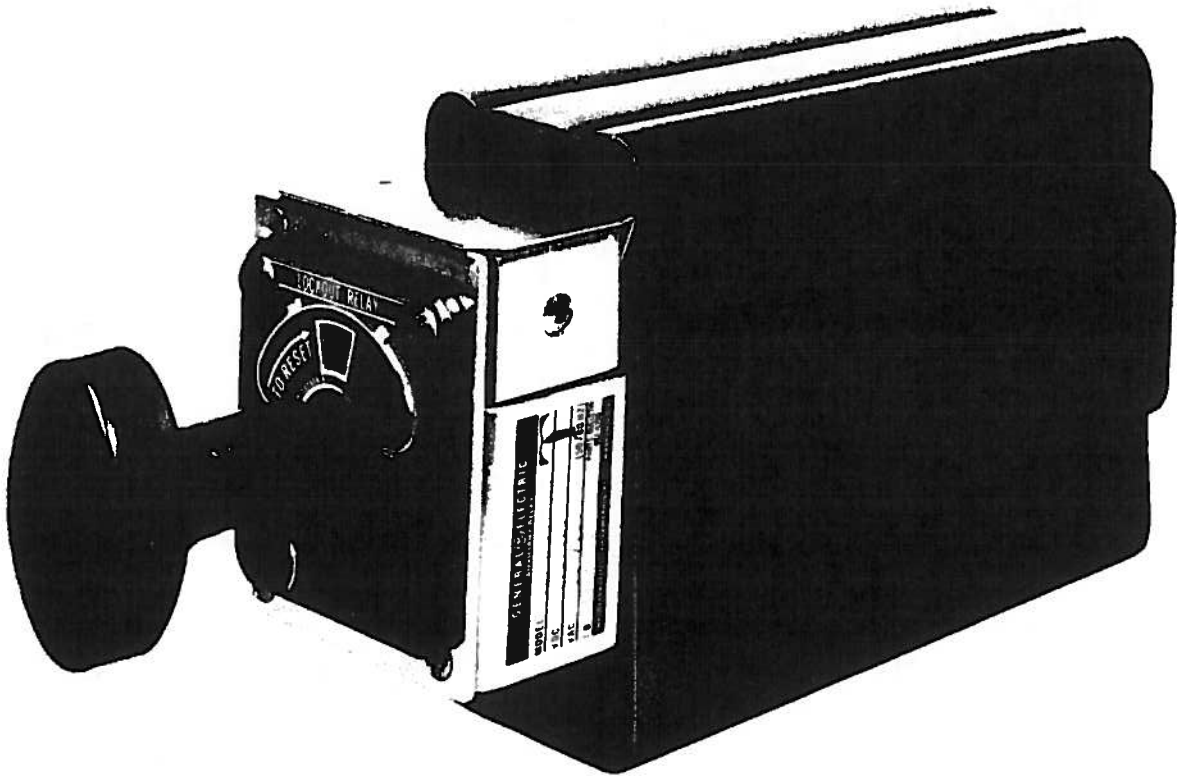
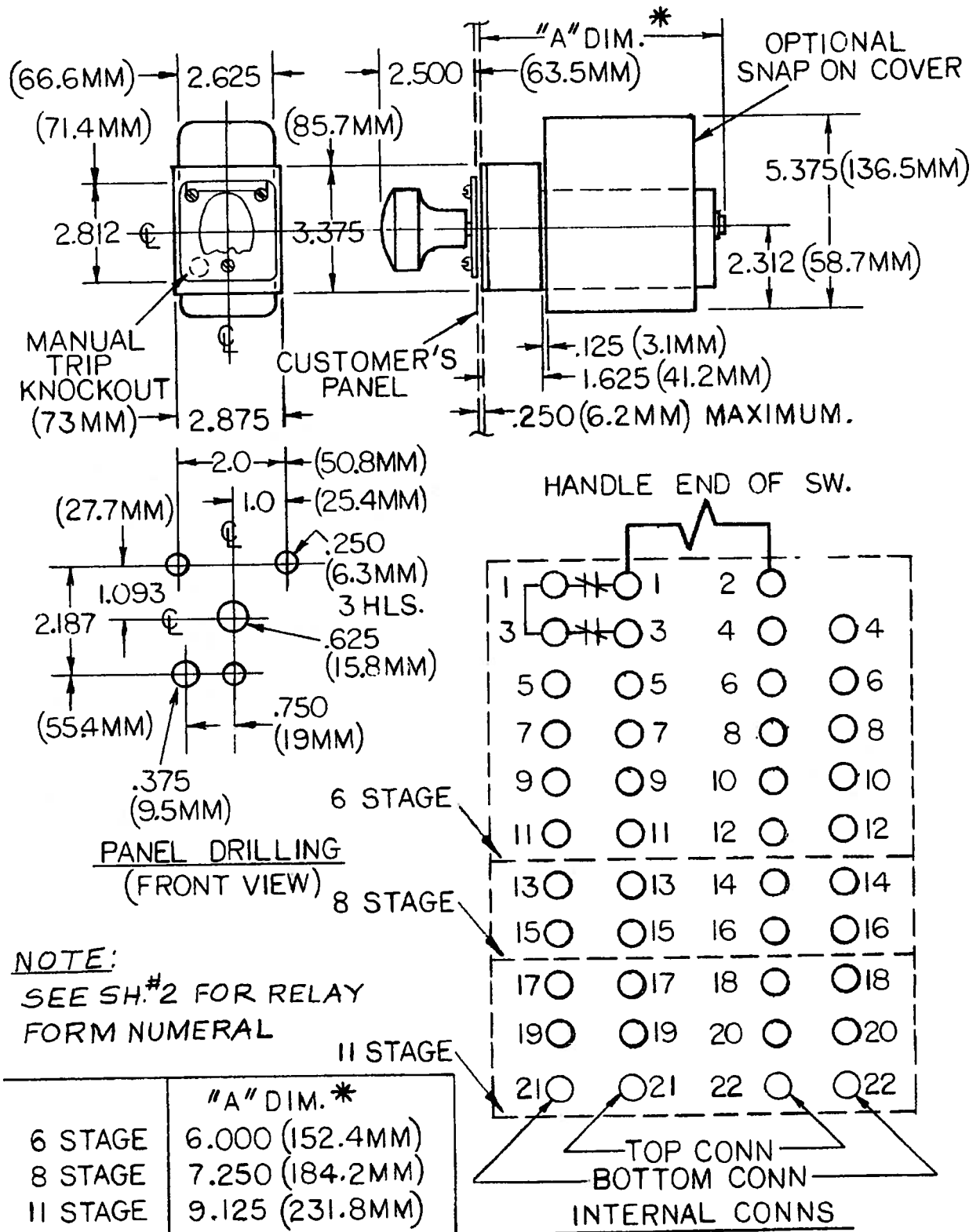

Fig. 1 (8043636) Type HSA11 Relay (Front Cover)



* Fig. 2 (0275A3211 Sh. 1 [3]) Outline, Panel Drilling and Internal Connections for Relay HSA11

* Revised since last issue

		RELAY FORM NUMERAL				CONTACT ARRANGEMENT	
VOLTS	48	110/125	220/250			RESET POSITION	
FREQUENCY	DC	DC	DC				
VOLTS	69	110/120	220/240				
FREQUENCY	50/60	50/60	50/60			OPEN	CLOSED
MODEL 12HSA11A	100	110	120			4T012	NONE
	101	111	121			5T012	4
	102	112	122			6T012	4#5
	103	113	123			7T012	4T06
	104	114	124			8T012	4T07
	105	115	125			9T012	4T08
	106	116	126			10T012	4T09
	107	117	127			11#12	4T010
	108	118	128			12	4T011
	109	119	129			NONE	4T012
MODEL 12HSA11B	200	220	240			4T016	NONE
	201	221	241			5T016	4
	202	222	242			6T016	4#5
	203	223	243			7T016	4T06
	204	224	244			8T016	4T07
	205	225	245			9T016	4T08
	206	226	246			10T016	4T09
	207	227	247			11T016	4T010
	208	228	248			12T016	4T011
	209	229	249			13T016	4T012
	210	230	250			14T016	4T013
	211	231	251			15#16	4T014
	212	232	252			16	4T015
	213	233	253			NONE	4T016
MODEL 12HSA11C	300	320	340			4T022	NONE
	301	321	341			5T022	4
	302	322	342			6T022	4#5
	303	323	343			7T022	4T06
	304	324	344			8T022	4T07
	305	325	345			9T022	4T08
	306	326	346			10T022	4T09
	307	327	347			11T022	4T010
	308	328	348			12T022	4T011
	309	329	349			13T022	4T012
	310	330	350			14T022	4T013
	311	331	351			15T022	4T014
	312	332	352			16T022	4T015
	313	333	353			17T022	4T016
	314	334	354			18T022	4T017
	315	335	355			19T022	4T018
	316	336	356			20T022	4T019
317	337	357			21#22	4T020	
318	338	358			22	4T021	
319	339	359			NONE	4T022	

Fig. 3 (0275A3211-0, Sh. 2) HSA Relay Form Numerals

0285A5691

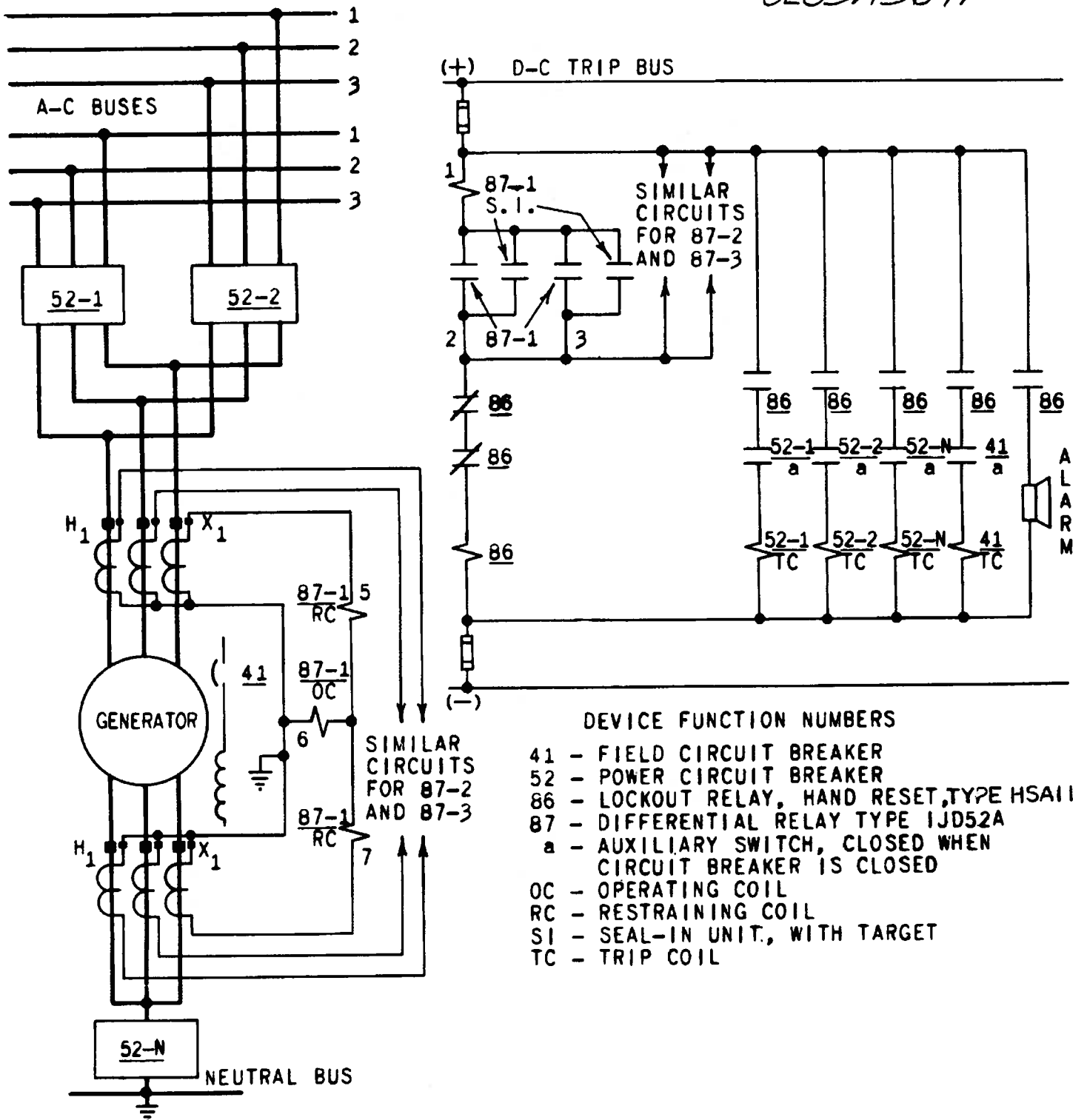

DEVICE FUNCTION NUMBERS

- 41 - FIELD CIRCUIT BREAKER
- 52 - POWER CIRCUIT BREAKER
- 86 - LOCKOUT RELAY, HAND RESET, TYPE HSA11
- 87 - DIFFERENTIAL RELAY TYPE IJD52A
- a - AUXILIARY SWITCH, CLOSED WHEN CIRCUIT BREAKER IS CLOSED
- OC - OPERATING COIL
- RC - RESTRAINING COIL
- SI - SEAL-IN UNIT, WITH TARGET
- TC - TRIP COIL

Fig. 4 (0285A5691-0) Typical Application of Type HSA11 Relays as Auxiliary Device in the Differential Protection of a Generator

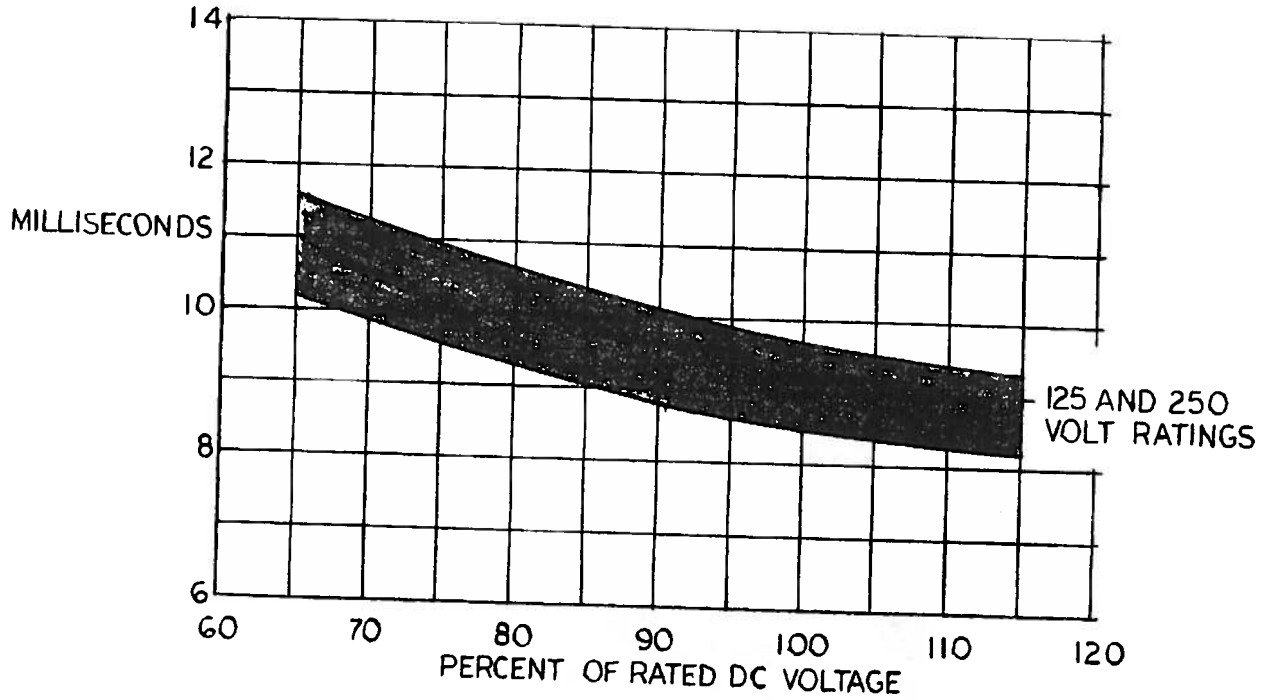

Fig. 5A (0258A5688-0) Typical Operating Characteristics of 8 and 11 Stage HSA Relays Showing Time to Close Normally Open Contacts

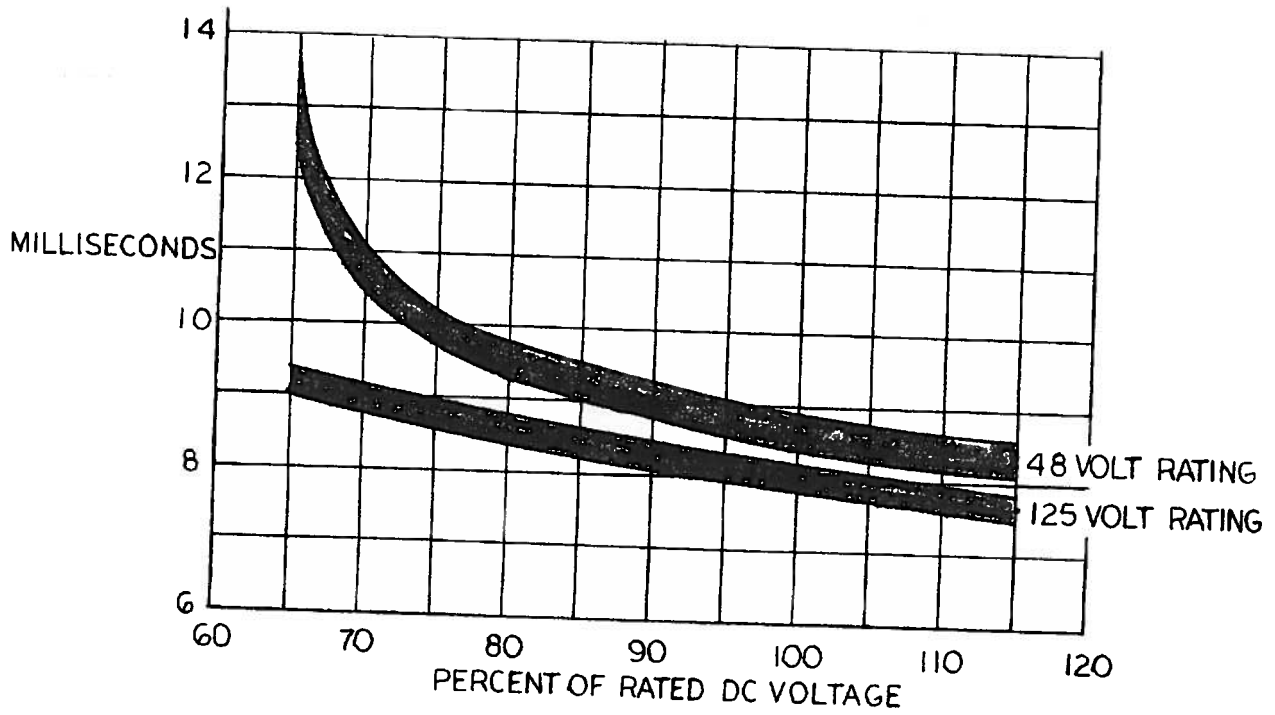

Fig. 5B (0258A5688-0) Typical Operating Characteristics of Six Stage HSA Relays Showing Time to Close Normally Open Contacts

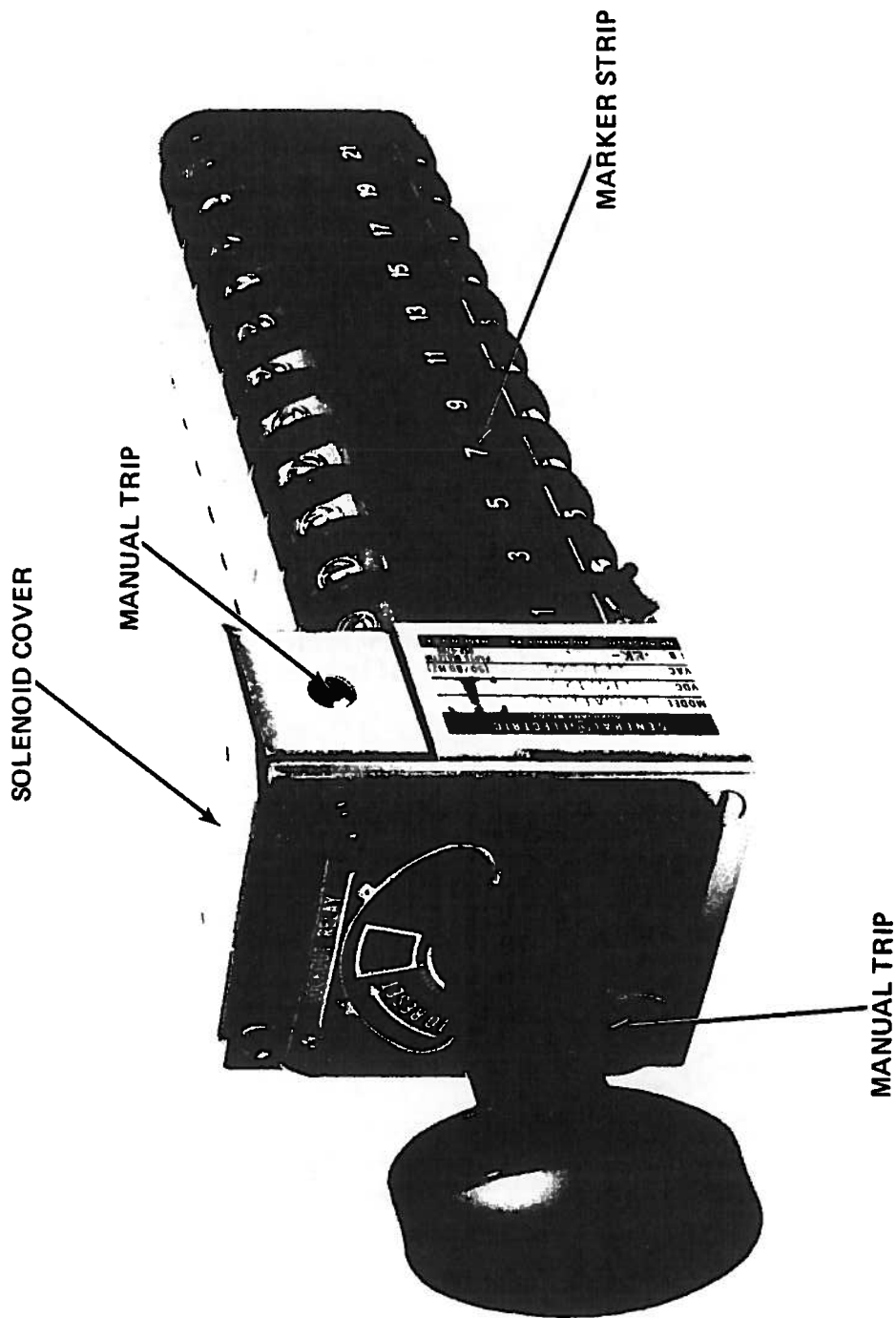

Fig. 6 (8043642) Eleven Stage HSA Relay in Reset
Condition with Cover Removed

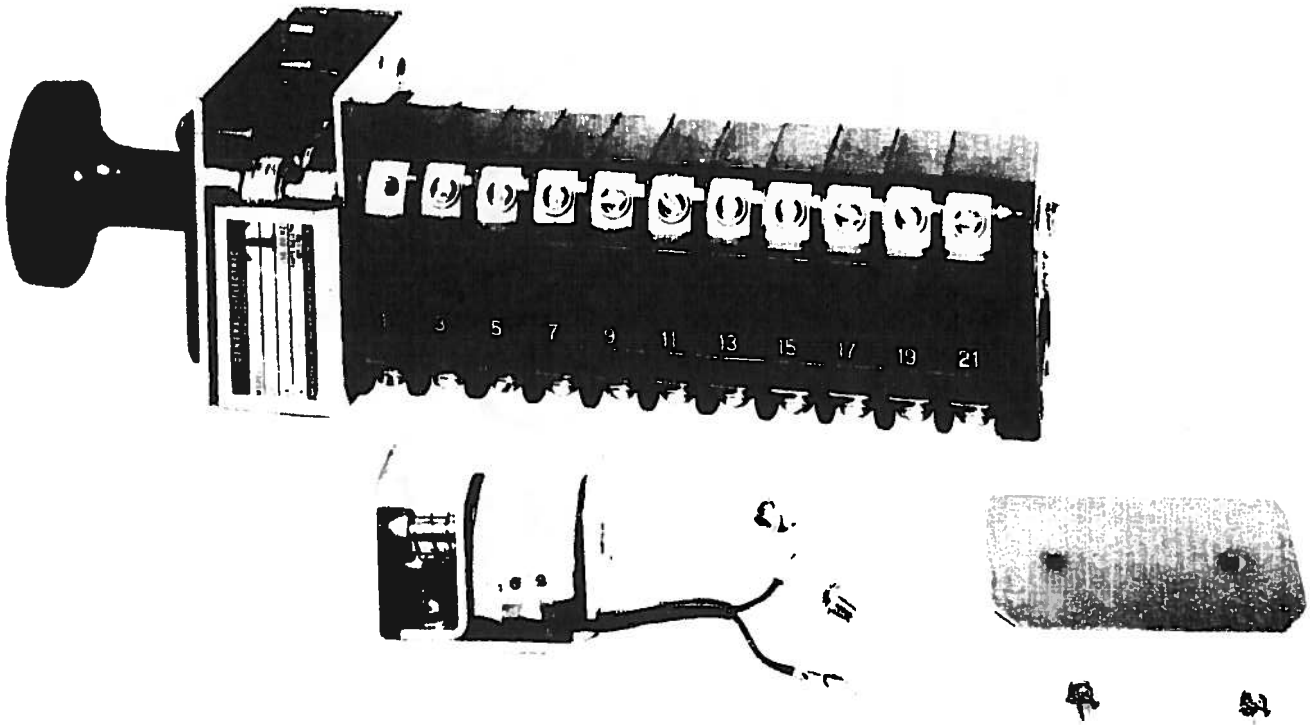

Fig. 7 (8043644) HSA11 Relay with Trip Solenoid and Solenoid Cover Removed

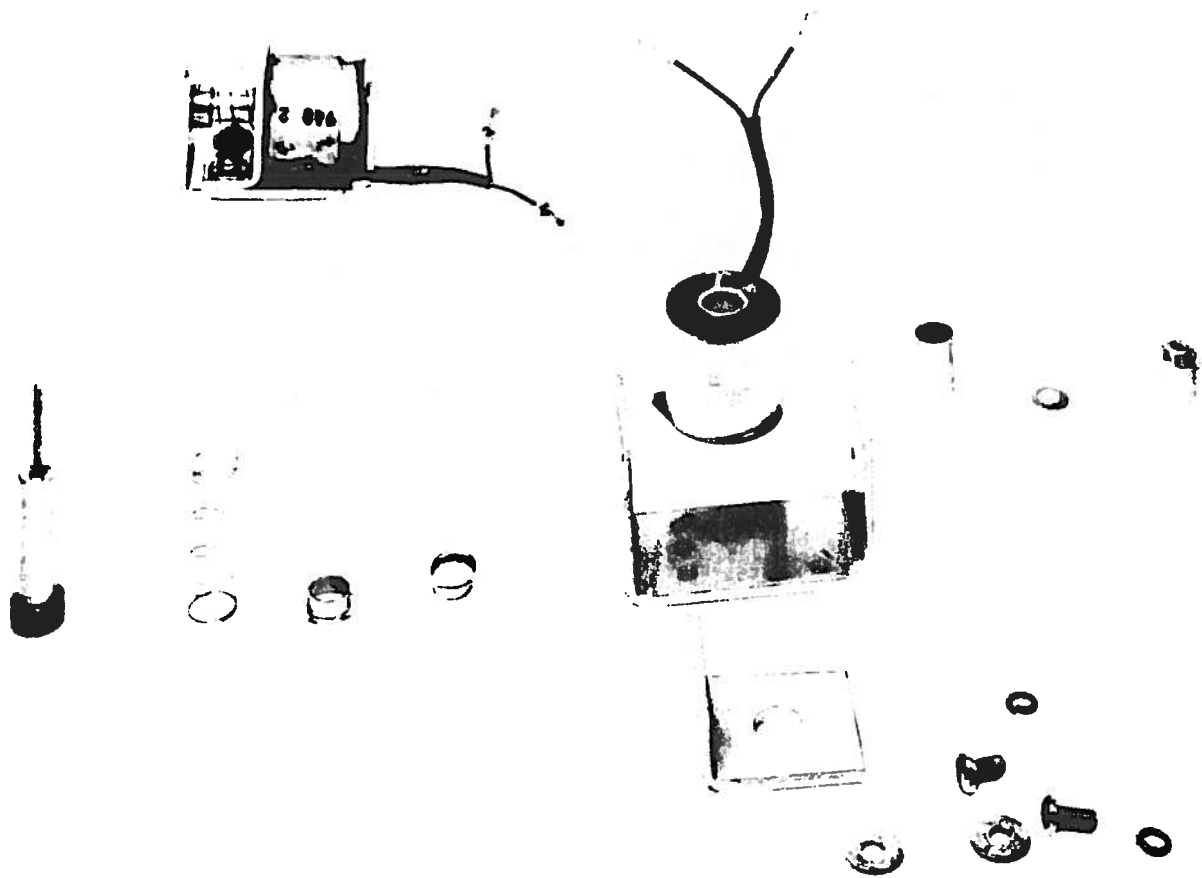

Fig. 8 (8043645) HSA11 Trip Solenoid with Solenoid Coil Removed



GE Power Management

**215 Anderson Avenue
Markham, Ontario
Canada L6E 1B3
Tel: (905) 294-6222
Fax: (905) 201-2098
www.ge.com/indsys/pm**